

ROCAM – 2018/2019
Mobili di Servizio “Panadora”



Instruments for Cooking & Service

Zona Industriale 2
Via dei Balconi 3
6917 Barbengo (TI)



Potete trovare i listini prezzi completi nelle ultime pagine

Come trovare il prezzo nel PDF:

premere CTRL + F, quindi scrivere il codice nella finestra di ricerca, premere ENTER fino a raggiungere il listino.

Orari di apertura

LU-VE 08.00 - 12.00 / 13.30 - 17.30

SA-DO CHIUSO

Contatti

+41 91 995 14 52

info@icsticino.ch

www.icsticino.ch



WAITER STATIONS

Restaurant solution



IT

La ricerca di nuove soluzioni e l'innovazione sui prodotti già esistenti sono le basi per garantire una gamma di articoli che può rispondere a tutte le esigenze degli operatori professionali. Le nostre attrezzature si differenziano non solo per l'alto valore tecnologico che semplifica il lavoro degli operatori professionali, ma anche per la loro essenzialità nelle forme.

EN

Looking for new solutions and innovation on existing articles are the starting points to guarantee a product range that can answer to each requirement of professionals. Our equipments are characterized not only by the high technology which makes work simpler, but also for the essential forms of items.

ALKOR

Modern furniture







ALKOR 2 AP

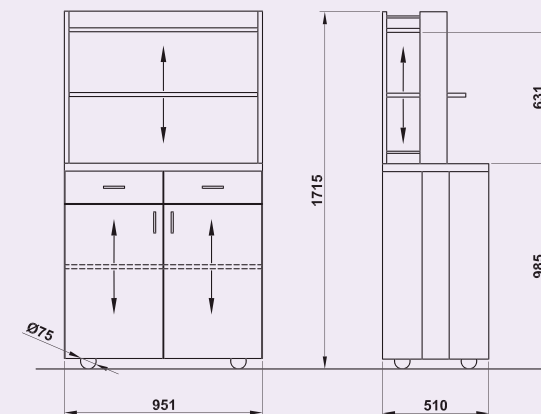

ALKOR 2 AP B/R

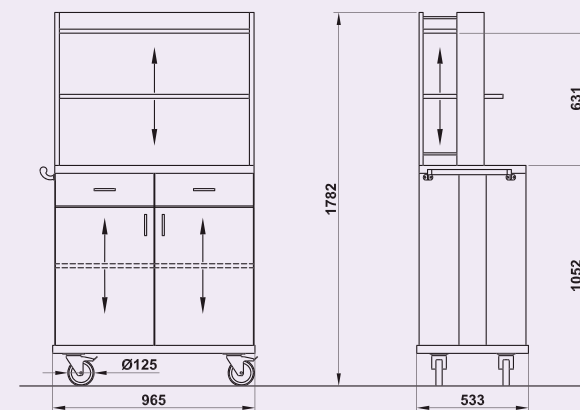

ALKOR 2 AP



ALL LAMINATED
AVAILABLE >> pag.10



TUTTI I MOBILI SONO SU RUOTE.
ALL DUMBWAITERS ARE ON CASTORS.

ALKOR	OPTIONS
ALKOR 2 AP	PP/F - TR - K
ALKOR 2 AP B/R	PP/F - TR - K

IT

Moderni mobili di servizio su ruote in legno laminato con dettagli color alluminio. Modelli a 2 sportelli chiusi con ripiano interno, ripiano intermedio e alzata regolabile in altezza o parte superiore chiusa da sportelli. Al posto dei cassetti è possibile prevedere un portaposate aperto a 6 compartimenti (opt. PP/F). I mobili possono essere dotati di base rinforzata con ruote più grandi (Ø125mm) e maniglia di spinta (B/R). Optional tramoggia estraibile su guide scorrevoli con sacco in cotone asportabile e lavabile (opt. TR).

EN

Modern dumbwaiters on castors made of laminated wood for the restaurant hall with aluminium-look details. Models with 2 doors with inner shelf, upper middle shelf can be height adjusted. The upper part can be closed by doors. Instead of drawers, dumbwaiters can be equipped with an open 6 compartments cutlery holder (opt. PP/F). They can be provided with a reinforced base with bigger castors (Ø125mm) and handle (B/R) and extractable hopper mounted on rails (opt. TR).



ALKOR 2 CH



ALKOR 2 CH B/R

ALKOR 2 CH

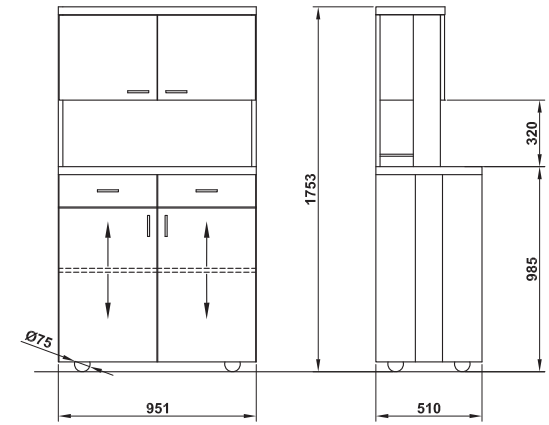

ALKOR 2 CH B/R

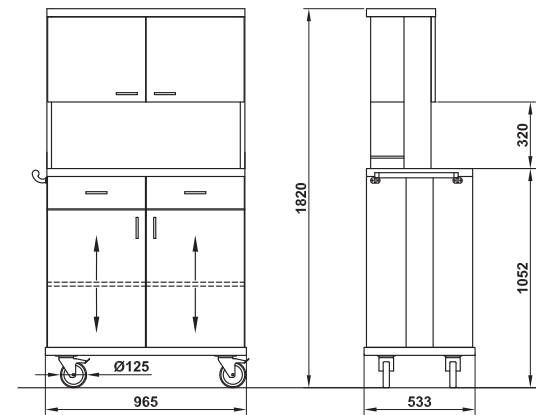

ALKOR	OPTIONS
ALKOR 2 CH	PP/F - TR - K
ALKOR 2 CH B/R	PP/F - TR - K

OPTIONS

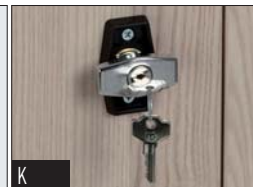
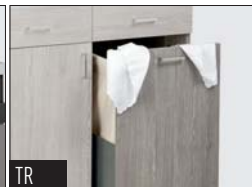

TUTTI I MOBILI SONO SU RUOTE.
ALL DUMBWAITERS ARE ON CASTORS.



SEPARATORI RIMUOVIBILI
REMOVABLE DIVIDERS



ALKOR 3 AP

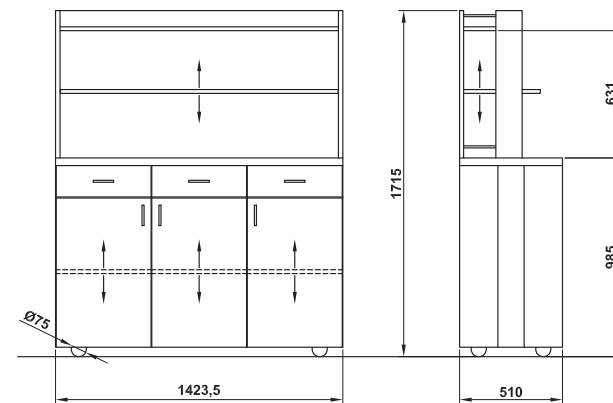

ALKOR 3 AP B/R

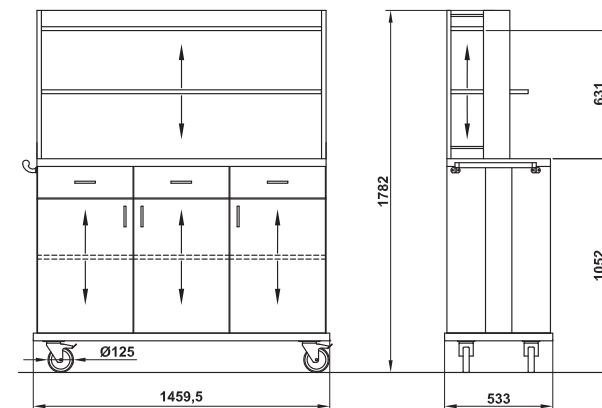

ALKOR 3 AP



ALL LAMINATED
AVAILABLE >> pag.10

ALKOR	OPTIONS
ALKOR 3 AP	PP/F - TR - K
ALKOR 3 AP B/R	PP/F - TR - K



TUTTI I MOBILI SONO SU RUOTE.
ALL DUMBWAITERS ARE ON CASTORS.

IT

Moderni mobili di servizio su ruote in legno laminato con dettagli color alluminio. Modelli a 3 sportelli chiusi con ripiano interno, ripiano intermedio e alzata regolabile in altezza o parte superiore chiusa da sportelli. Al posto dei cassetti è possibile prevedere un portaposate aperto a 9 scompartimenti (opt. PP/F). I mobili possono essere dotati di base rinforzata con ruote più grandi (Ø125mm) e maniglia di spinta (B/R). Optional tramoggia estraibile su guide scorrevoli con sacco in cotone asportabile e lavabile (opt. TR).

EN

Modern dumbwaiters on castors made of laminated wood for the restaurant hall with aluminium-look details. Models with 3 doors with inner shelf, upper middle shelf can be height adjusted. The upper part can be closed by doors. Instead of drawers, dumbwaiters can be equipped with an open 9 compartments cutlery holder (opt. PP/F). They can be provided with a reinforced base with bigger castors (Ø125mm) and handle (B/R) and extractable hopper mounted on rails (opt. TR).



ALKOR 3 CH

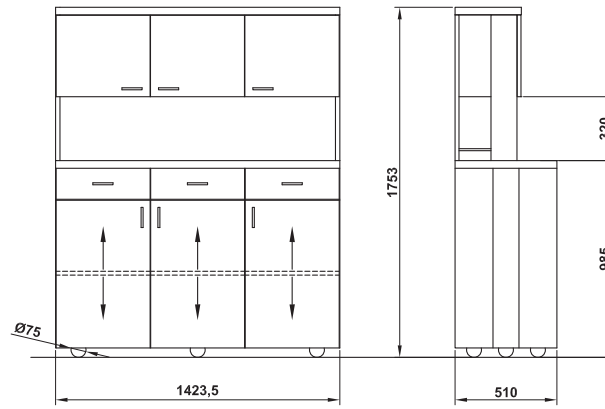

ALKOR 3 CH B/R

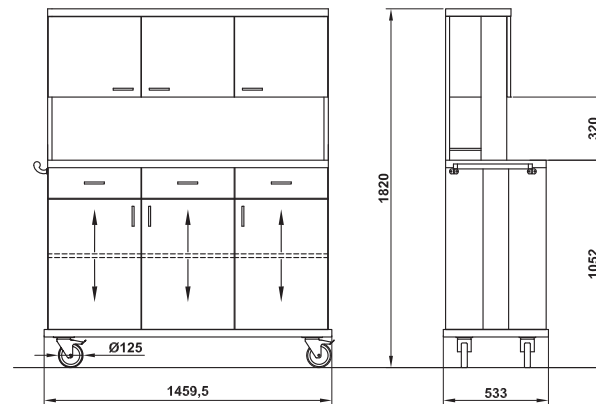

ALKOR 3 CH + K

ALKOR 3 CH

OPTIONS

ALKOR	OPTIONS
ALKOR 3 CH	PP/F - TR - K
ALKOR 3 CH B/R	PP/F - TR - K

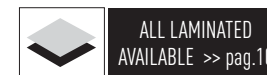
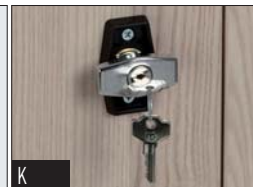
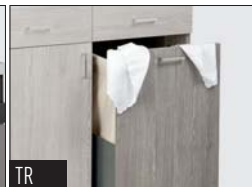

TUTTI I MOBILI SONO SU RUOTE.
ALL DUMBWAITERS ARE ON CASTORS.



SEPARATORI RIMUOVIBILI
REMOVABLE DIVIDERS



ALKOR 2 B



ALKOR 3 B

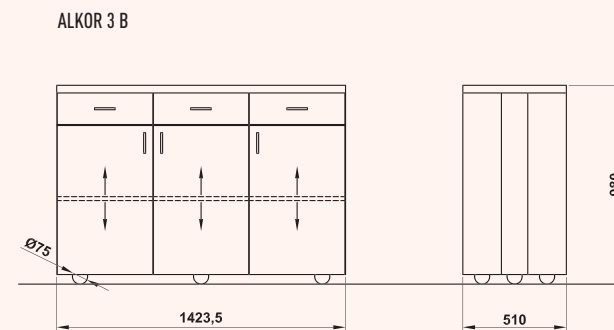
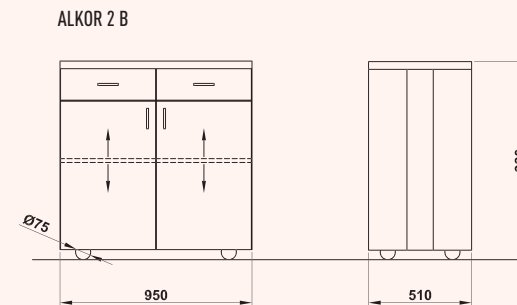

 ALL LAMINATED AVAILABLE >> pag.10



TUTTI I MOBILI SONO SU RUOTE.
ALL DUMBWAITERS ARE ON CASTORS.

ALKOR	OPTIONS
ALKOR 2 B	PP/F - TR - K- S/Q
ALKOR 2 B B/R	PP/F - TR - K- S/Q

IT

Moderni mobili di servizio su ruote in legno laminato con dettagli color alluminio. Modelli a 2 o 3 sportelli chiusi con ripiano interno, ripiano intermedio e alzata regolabile in altezza. Al posto dei cassetti è possibile prevedere un portaposate aperto a 6-9 scompartimenti (opt. PP/F). I mobili possono essere dotati di base rinforzata con ruote più grandi (Ø125mm) e maniglia di spinta (B/R). Opzionale tramoggia estraibile su guide scorrevoli con sacco in cotone asportabile e lavabile (opt. TR).

EN

Modern dumbwaiters on castors made of laminated wood for the restaurant hall with aluminium-look details. Models with 2 or 3 doors with inner shelf, upper middle shelf can be height adjusted. Instead of drawers, dumbwaiters can be equipped with an open 6-9 compartments cutlery holder (opt. PP/F). They can be provided with a reinforced base with bigger castors (Ø125mm) and handle (B/R) and extractable hopper mounted on rails (opt. TR).



ALKOR 2 B B/R

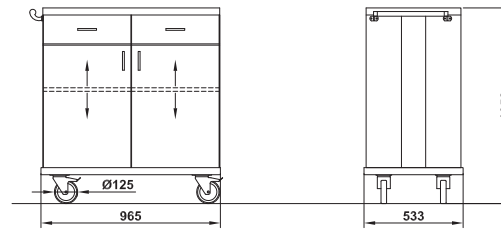

ALKOR 3 B B/R

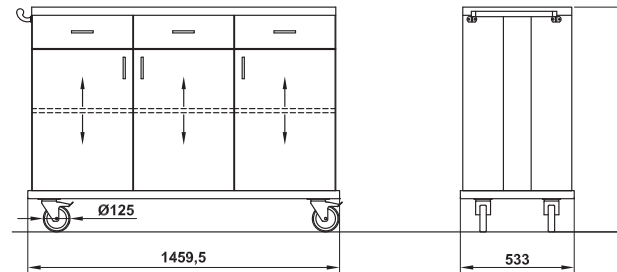

ALKOR 2 B B/R

OPTIONS

ALKOR	OPTIONS
ALKOR 3 B	PP/F - TR - K- S/Q
ALKOR 3 B B/R	PP/F - TR - K- S/Q

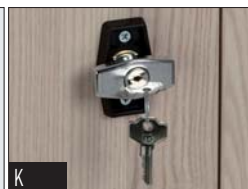

ALL LAMINATED AVAILABLE >> pag.10



TUTTI I MOBILI SONO SU RUOTE.
ALL DUMBWAITERS ARE ON CASTORS.

POLAR

Outdoor Furniture







POLAR 2 AP

POLAR 2 AP

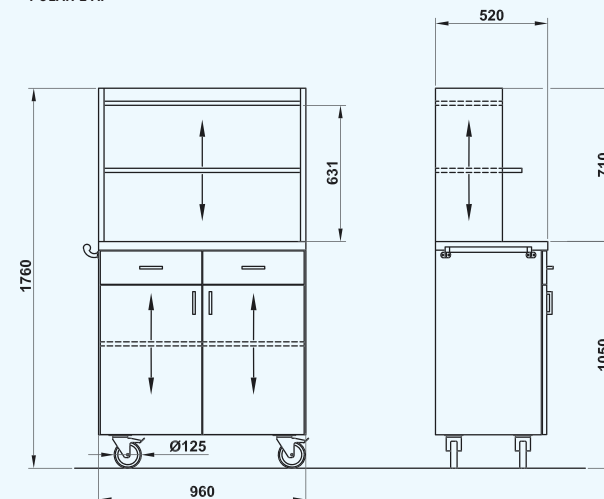

RA



PP/F

IT

Per ottimizzare il servizio all'esterno è disponibile una linea di mobili costruita interamente in acciaio inox AISI 304. La versione alta di questo mobile può avere la parte superiore aperta con 2 ripiani oppure completamente chiusa da 2 pratiche antine. Tutti i modelli sono dotati di ruote Ø125mm di cui 2 con freno e una comoda maniglia di spinta. Per una gestione ottimale delle posate è possibile scegliere la versione con 2 cassetti oppure con il pratico portaposate a 6 scomparti (Opt. PP/F) chiuso da uno sportello. Per la gestione dei calici è possibile prevedere una pratica rastrelliera (Opt. RA).

EN

To optimize the outdoor service it's available a line of dumbwaiters built completely in stainless steel AISI 304. The high models can have an open upper part with 2 shelves or completely closed by 2 small doors. Each dumbwaiter is mounted on wheels Ø125mm., 2 with brakes and a practical pushing handle. To organize cutlery are available dumbwaiters with 2 drawers or with 6 compartments closed by a small door (Opt. PP/F). A useful glass rack for wine glasses is available as an option (opt. RA).

POLAR

OPTIONS

POLAR 2 AP

PP/F-RA



POLAR 2 CH



POLAR 2 CH

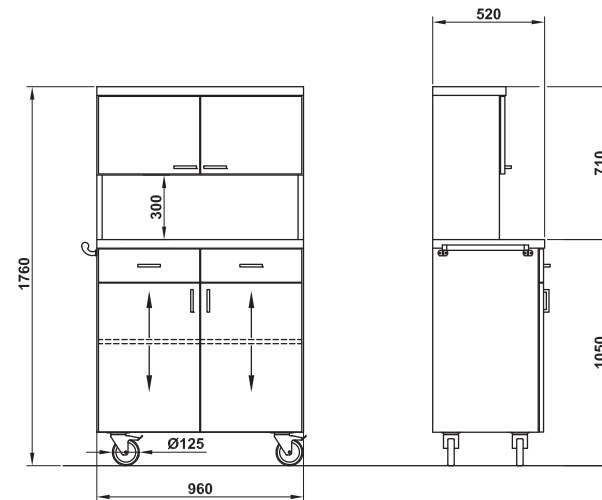

POLAR	OPTIONS
POLAR 2 CH	PP/F-RA

OPTIONS





POLAR 2 B



POLAR 2 B + PP/F



POLAR 2 AL

POLAR	OPTIONS
POLAR 2 B	PP/F
POLAR 2 AL	PP/F-RA

IT

La linea Polar è disponibile anche in versione bassa. Tutti i modelli sono dotati di ruote Ø125mm di cui 2 con freno e una comoda maniglia di spinta. Per una gestione ottimale delle posate è possibile scegliere la versione con 2 cassetti oppure con il pratico portaposate a 6 scomparti (Opt. PP/F) chiuso da uno sportello.

EN

Polar line is also available in a low version. Each dumbwaiter is mounted on wheels Ø125mm., 2 with brakes and a practical pushing handle. To organize cutlery are available dumbwaiters with 2 drawers or with 6 compartments closed by a small door (Opt. PP/F).

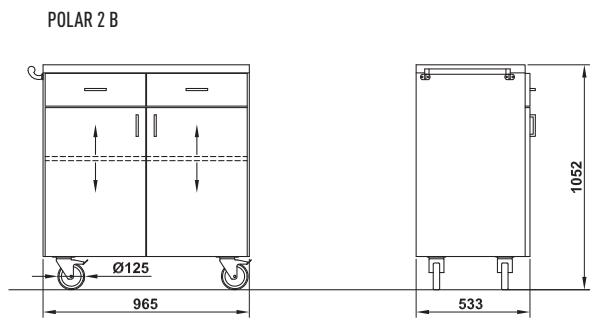
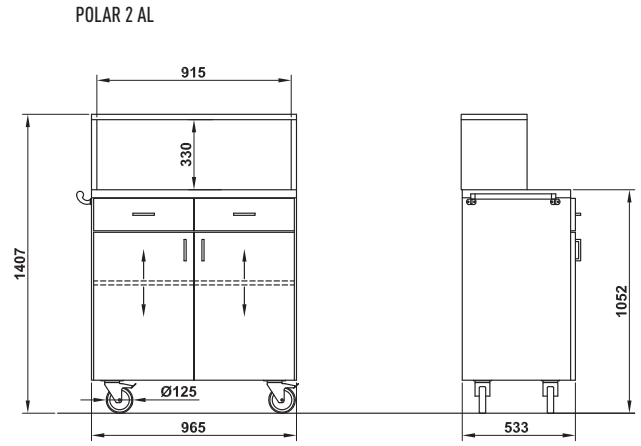

PERSEO

Evergreen Style







PERSEO A/2



PERSEO A/1



ALL LAMINATED
AVAILABLE >> pag.10



TUTTI I MOBILI SONO SU RUOTE.
ALL DUMBWAITERS ARE ON CASTORS.

PERSEO	OPTIONS
PERSEO A/1	B/R - PP/F - PER/CO - K
PERSEO A/2	B/R - PP/F - PER/CO - K

IT

Mobili di servizio su ruote in legno laminato per la sala ristorante. Modelli con 2 cassetti e 1 o 2 sportelli con ripiano interno. Al posto dei cassetti è possibile avere un portaposate aperto a 6 scompartimenti (opt. PP/F). I mobili possono essere dotati di base rinforzata con ruote più grandi (Ø125mm) e maniglia di spinta (opt. B/R), è inoltre disponibile una copertura di protezione in poliestere (opt. PER/CO).

EN

Dumbwaiters on castors made of laminated wood for the restaurant hall. Models with 2 drawers and 1 or 2 doors with inner shelf. Instead of drawers, dumbwaiters can be equipped with an open 6-compartment cutlery holder (opt. PP/F). They can be provided with a reinforced base with bigger castors (Ø125mm) and handle (opt. B/R) and a polyester protection covering (opt. PER/CO).



PERSEO A1

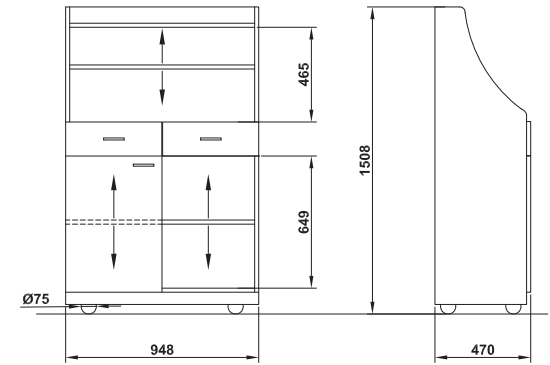

PERSEO A2

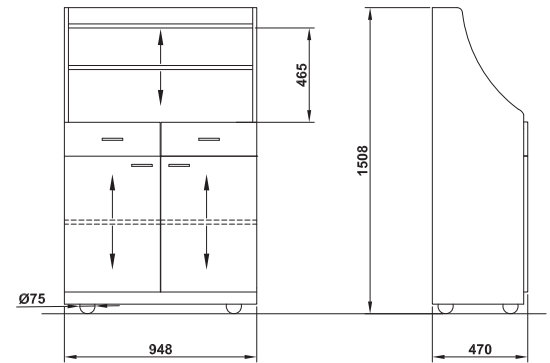

OPTIONS

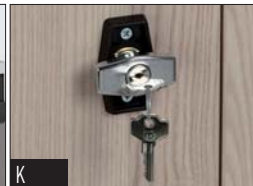

ALL LAMINATED
AVAILABLE >> pag.10



PERSEO A/T



PERSEO A/TA

PERSEO A/T

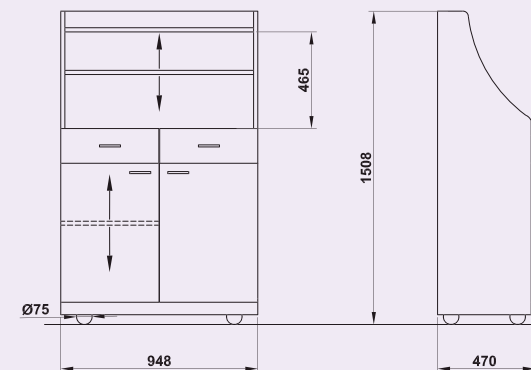

PERSEO A/TA

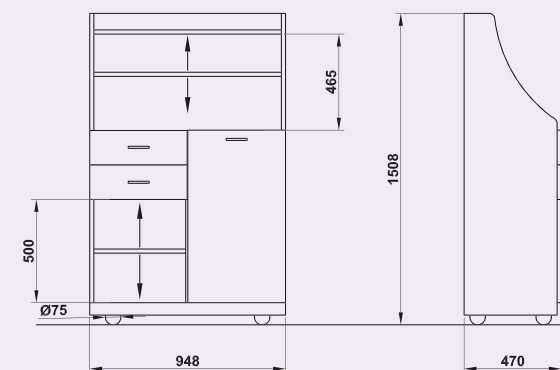

PERSEO	OPTIONS
PERSEO A/T	B/R - PP/F - PER/CO - K
PERSEO A/TA	B/R - PER/CO - K

 ALL LAMINATED AVAILABLE >> pag.10



TUTTI I MOBILI SONO SU RUOTE.
ALL DUMBWAITERS ARE ON CASTORS.

IT

Mobili di servizio su ruote in legno laminato per la sala ristorante. Modelli con 2 cassetti e 1 o 2 sportelli con ripiano interno. Al posto dei cassetti è possibile avere un portaposate aperto a 6 scompartimenti (opt. PP/F). La versione H prevede uno spazio portamenù. I mobili possono essere dotati di base rinforzata con ruote più grandi (Ø125mm) e maniglia di spinta (opt. B/R), è inoltre disponibile una copertura di protezione in poliestere (opt. PER/CO).

EN

Dumbwaiters on castors made of laminated wood for the restaurant hall. Models with 2 drawers and 1 or 2 doors with inner shelf. Instead of drawers, dumbwaiters can be equipped with an open 6-compartment cutlery holder (opt. PP/F). The H version is equipped by a useful menu-holder. They can be provided with a reinforced base with bigger castors (Ø125mm) and handle (opt. B/R) and a polyester protection covering (opt. PER/CO).



PERSEO H/1

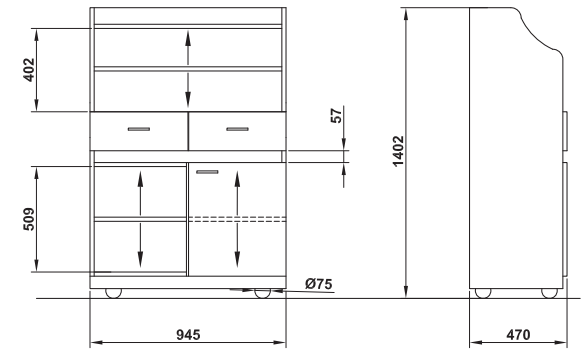

PERSEO H/2

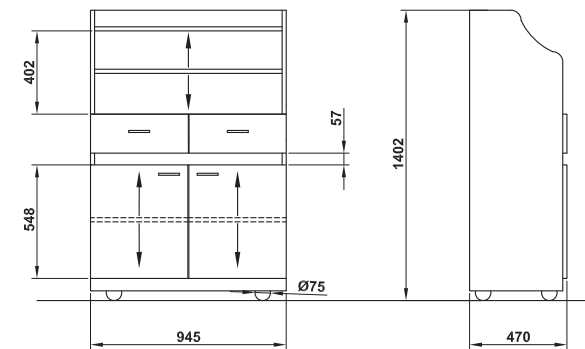

PERSEO H/1

PERSEO H/2



TUTTI I MOBILI SONO SU RUOTE.
ALL DUMBWAITERS ARE ON CASTORS.



ALL LAMINATED
AVAILABLE >> pag.10

OPTIONS



PER/CO



B/R



PP/F

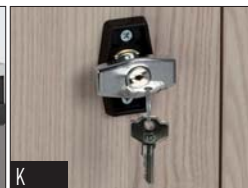

K



PERSEO	OPTIONS
PERSEO H/1	B/R - PP/F - PER/CO - K
PERSEO H/2	B/R - PP/F - PER/CO - K



PERSEO G



PERSEO 75

PERSEO G

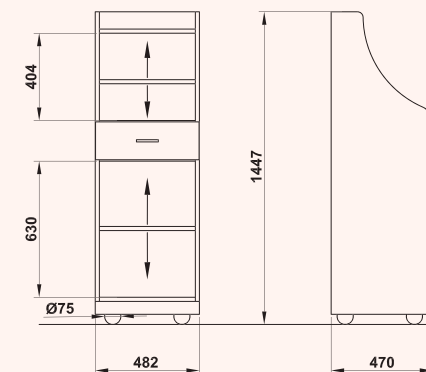

PERSEO 75

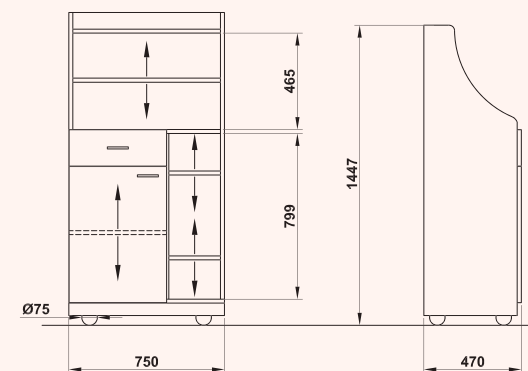

ALL LAMINATED
AVAILABLE >> pag.10



TUTTI I MOBILI SONO SU RUOTE.
ALL DUMBWAITERS ARE ON CASTORS.

PERSEO	OPTIONS
PERSEO G	PP/F - K
PERSEO 75	B/R - PP/F - K

IT

Mobili di servizio su ruote in legno laminato per la sala ristorante. Svariati modelli con cassetti, sportelli o tramogge estraibili su guide scorrevoli. A seconda del modello i mobili possono avere un portaposate aperto a 3-6 scompartimenti (opt. PP/F), tranne i modelli a 1 cassetto, tutti i mobili possono essere dotati di base rinforzata con ruote più grandi (Ø125mm) e maniglia di spinta (opt. B/R).

EN

Dumbwaiters on castors made of laminated wood for the restaurant hall. Several models with drawers, doors or extractable hoppers mounted on rails. Instead of drawers, dumbwaiters can be equipped with an open 3-6-compartments cutlery holder (opt. PP/F), except the models with 1 drawer, each dumbwaiter can be provided with a reinforced base with bigger castors (Ø125mm) and a handle (opt. B/R).



PERSEO B/2

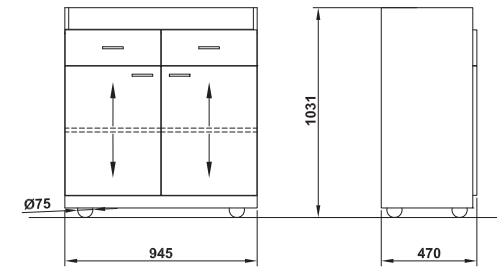

PERSEO B/TA

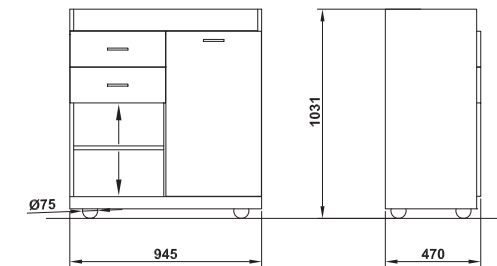

PERSEO B/2

PERSEO B/TA

 ALL LAMINATED AVAILABLE >> pag.10



TUTTI I MOBILI SONO SU RUOTE.
ALL DUMBWAITERS ARE ON CASTORS.



ALL LAMINATED AVAILABLE >> pag.10

OPTIONS



PER/CO



B/R



PP/F

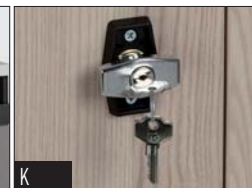

K



PERSEO	OPTIONS
PERSEO B/2	B/R - PP/F - K
PERSEO B/TA	B/R - K

MEDUSA

Classic style

IT

Mobili di servizio su ruote in legno laminato per la sala ristorante a due o tre sportelli con una profondità di 60cm. Possono essere dotati di base rinforzata con ruote più grandi (Ø125mm) e maniglia di spinta (opt. B/R). I modelli MEDUSA 2/AL e 3/AL sono dotati di antine con vetro satinato.

EN

Dumbwaiters on castors made of laminated wood for the restaurant hall with 2 or 3 drawers. 60cm. width. They can be provided with a reinforced base with bigger castors (Ø125mm) and handle (opt. B/R). MEDUSA 2/AL and 3/AL are equipped with frosted glass doors on the upper part.



MEDUSA 3/AL



MEDUSA 2/AL



MEDUSA 2/2

MEDUSA	OPTIONS
MEDUSA 2/2	TR - B/R - PP/F - K
MEDUSA 2/AL	TR - B/R - PP/F - K
MEDUSA 3/2	TR - B/R - PP/F - K
MEDUSA 3/AL	TR - B/R - PP/F - K



TUTTI I MOBILI SONO SU RUOTE.
ALL DUMBWAITERS ARE ON CASTORS.



MEDUSA 3/2

MEDUSA 3/AL

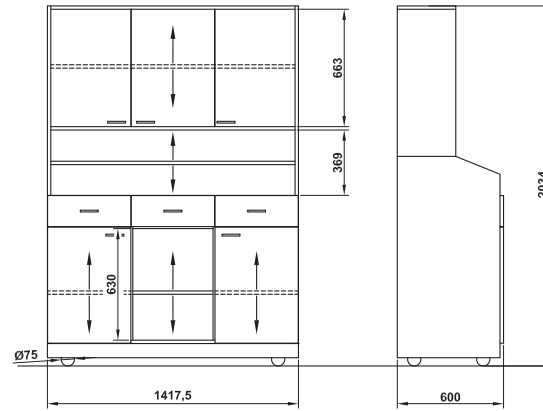

MEDUSA 2/AL

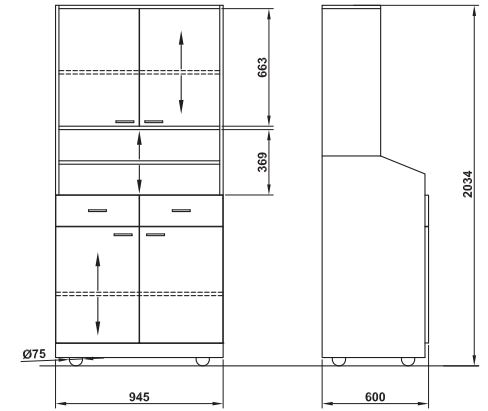

MEDUSA 3/2

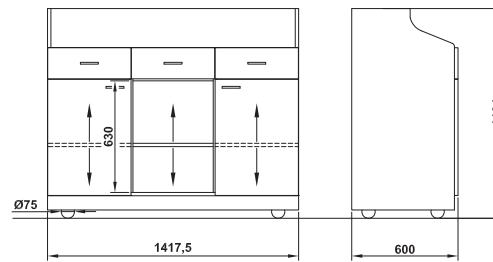

MEDUSA 2/2

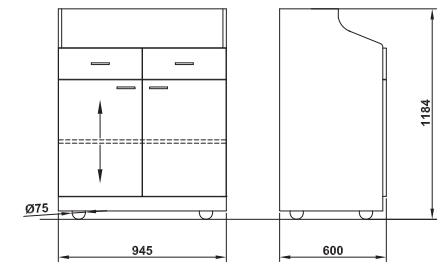

OPTIONS

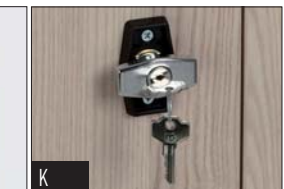
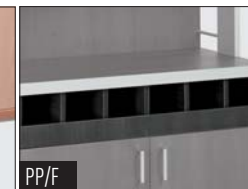

Materials & Decors



LEGNO LAMINATO - LAMINATED WOOD

DECORI LEGNO - WOODEN DECORS



LBE

Betulla
Birch



LRV

Rovere
Oak



LOM

Olmo
Elm



LSA

Sabbia
Sand

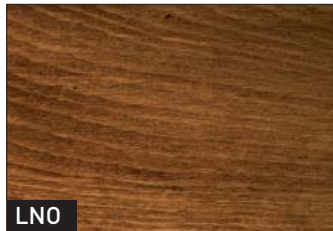

LNO

Noce
Walnut



LWE

Wengè



LNE

Nebbia
Fog



LAN

Antracite
Anthracite



LEGNO LAMINATO - LAMINATED WOOD

TINTE UNITE - PLAIN DECORS



LBV

Bianco Venato
Veined white

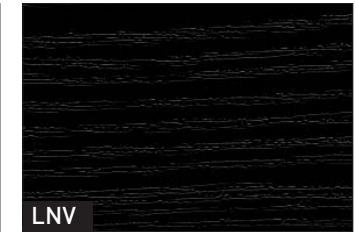

LNV

Nero venato
Veined black

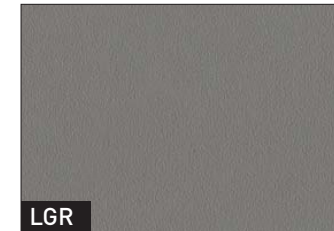

LGR

Grigio
Grey

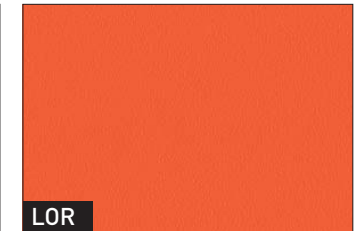

LOR

Arancio
Orange



LBL

Blu
Blue



LVA

Verde acqua
Aquamarine



LEGNO LAMINATO - LAMINATED WOOD

MATERICI - MATERIC DECORS



LPS

Pietra scura
Dark stone

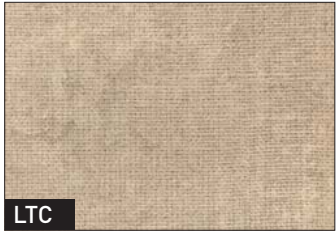

LTC

Tessuto chiaro
Light fabric



LEGNO MASSELLO - SOLID WOOD



MNL

Naturale
Natural



MVR

Rovere
Oak



MNO

Noce
Walnut



MGR

Grigio venato
Veined grey







MWE







Wengè



RAL

RAL

PRODOTTI		OPTIONAL			
ARTICOLO	DESCRIZIONE	PREZZO	COD.	DESCRIZIONE	
ALKOR - Design moderna					
		Moderni mobili di servizio su ruote in legno laminato con dettagli color alluminio. 2 sportelli chiusi e alzata con 2 ripiani. Disponibile in 16 colori.	CHF 1'457.00		
ALKOR 2 AP				PP/F	Portaposate aperto -
				TR	Tramoggia CHF 334.80
Peso: 108 kg		4 ruote ø75mm		K	Chiusura per cassetto/porta (x1) CHF 108.50
Pag. 94 catalogo 2018				P	Ripiano extra CHF 38.75
		Moderni mobili di servizio su ruote in legno laminato con dettagli color alluminio. 2 sportelli chiusi, alzata con 2 ripiani, base rinforzata e maniglia di spinta. Disponibile in 16 colori.	CHF 1'674.00		
ALKOR 2 AP B/R				PP/F	Portaposate aperto -
				TR	Tramoggia CHF 334.80
Peso: 117 kg		4 ruote ø125mm, 2 con freno.		K	Chiusura per cassetto/porta (x1) CHF 108.50
Pag. 94 catalogo 2018				P	Ripiano extra CHF 38.75
		Moderni mobili di servizio su ruote in legno laminato con dettagli color alluminio. 2 sportelli chiusi e parte superiore chiusa da 2 sportelli. Disponibile in 16 colori.	CHF 1'683.30		
ALKOR 2 CH				PP/F	Portaposate aperto -
				TR	Tramoggia CHF 334.80
Peso: 116 kg		4 ruote ø75mm		K	Chiusura per cassetto/porta (x1) CHF 108.50
Pag. 95 catalogo 2018				P	Ripiano extra CHF 38.75
		Moderni mobili di servizio su ruote in legno laminato con dettagli color alluminio. 2 sportelli chiusi, alzata chiusa da 2 sportelli, base rinforzata e maniglia di spinta. Disponibile in 16 colori.	CHF 1'875.50		
ALKOR 2 CH B/R				PP/F	Portaposate aperto -
				TR	Tramoggia CHF 334.80
Peso: 125 kg		4 ruote ø125mm, 2 con freno.		K	Chiusura per cassetto/porta (x1) CHF 108.50
Pag. 95 catalogo 2018				P	Ripiano extra CHF 38.75
		Moderni mobili di servizio su ruote in legno laminato con dettagli color alluminio. 3 sportelli chiusi e alzata con 2 ripiani. Disponibile in 16 colori.	CHF 1'829.00		
ALKOR 3 AP				PP/F	Portaposate aperto -
				TR	Tramoggia CHF 334.80
Peso: 155 kg		4 ruote ø75mm		K	Chiusura per cassetto/porta (x1) CHF 108.50
Pag. 96 catalogo 2018				P	Ripiano extra CHF 38.75
		Moderni mobili di servizio su ruote in legno laminato con dettagli color alluminio. 3 sportelli chiusi, alzata con 2 ripiani, base rinforzata e maniglia di spinta. Disponibile in 16 colori.	CHF 2'092.50		
ALKOR 3 AP B/R				PP/F	Portaposate aperto -
				TR	Tramoggia CHF 334.80
Peso: 166 kg		4 ruote ø125mm, 2 con freno.		K	Chiusura per cassetto/porta (x1) CHF 108.50
Pag. 96 catalogo 2018				P	Ripiano extra CHF 38.75







PRODOTTI			OPTIONAL			
		Moderni mobili di servizio su ruote in legno laminato con dettagli color alluminio.				
ALKOR 3 CH		3 sportelli chiusi e parte superiore chiusa da 2 sportelli.		PP/F	Portaposate aperto	-
		Disponibile in 16 colori.	CHF 2'092.50	TR	Tramoggia	CHF 334.80
Peso: 166 kg		4 ruote ø75mm		K	Chiusura per cassetto/porta (x1)	CHF 108.50
Pag. 97 catalogo 2018				P	Ripiano extra	CHF 38.75
		Moderni mobili di servizio su ruote in legno laminato con dettagli color alluminio.				
ALKOR 3 CH B/R		2 sportelli chiusi, alzata chiusa da 2 sportelli, base rinforzata e maniglia di spinta.		PP/F	Portaposate aperto	-
		Disponibile in 16 colori.	CHF 2'356.00	TR	Tramoggia	CHF 334.80
Peso: 177 kg		4 ruote ø125mm, 2 con freno.		K	Chiusura per cassetto/porta (x1)	CHF 108.50
Pag. 97 catalogo 2018				P	Ripiano extra	CHF 38.75
		Moderni mobili di servizio su ruote in legno laminato con dettagli color alluminio.		S/Q-2	Spondina di contenimento	CHF 142.60
ALKOR 2 B		2 sportelli.		PP/F	Portaposate aperto	-
		Disponibile in 16 colori.	CHF 1'271.00	TR	Tramoggia	CHF 334.80
Peso: 69 kg		4 ruote ø75mm		K	Chiusura per cassetto/porta (x1)	CHF 108.50
Pag. 98 catalogo 2018				P	Ripiano extra	CHF 38.75
		Moderni mobili di servizio su ruote in legno laminato con dettagli color alluminio.		S/Q-2	Spondina di contenimento	CHF 142.60
ALKOR 2 B B/R		2 sportelli, base rinforzata e maniglia di spinta.		PP/F	Portaposate aperto	-
		Disponibile in 16 colori.	CHF 1'503.50	TR	Tramoggia	CHF 334.80
Peso: 76 kg		4 ruote ø125mm, 2 con freno.		K	Chiusura per cassetto/porta (x1)	CHF 108.50
Pag. 99 catalogo 2018				P	Ripiano extra	CHF 38.75
		Moderni mobili di servizio su ruote in legno laminato con dettagli color alluminio.		S/Q-3	Spondina di contenimento	CHF 170.50
ALKOR 3 B		3 sportelli.		PP/F	Portaposate aperto	-
		Disponibile in 16 colori.	CHF 1'581.00	TR	Tramoggia	CHF 334.80
Peso: 105 kg		5 ruote ø75mm		K	Chiusura per cassetto/porta (x1)	CHF 108.50
Pag. 98 catalogo 2018				P	Ripiano extra	CHF 38.75
		Moderni mobili di servizio su ruote in legno laminato con dettagli color alluminio.		S/Q-3	Spondina di contenimento	CHF 170.50
ALKOR 3 B B/R		3 sportelli, base rinforzata e maniglia di spinta.		PP/F	Portaposate aperto	-
		Disponibile in 16 colori.	CHF 1'829.00	TR	Tramoggia	CHF 325.50
Peso: 112 kg		4 ruote ø125mm, 2 con freno.		K	Chiusura per cassetto/porta (x1)	CHF 108.50
Pag. 99 catalogo 2018				P	Ripiano extra	CHF 38.75

POLAR - Forniture per uso esterno





		Moderni mobili di servizio completamente in acciaio inox AISI 304				
POLAR 2 AL		1 ripiano nella pratica alzata, 2 cassetti e 2 porte. Dotati di maniglia di spinta.				
			CHF 2'976.00	RA	Rastrelliera in acciaio inox	CHF 248.00
Peso: 84 kg		4 Ruote ø125mm di cui 2 con freno				
Pag. 104 catalogo 2018						
		Moderni mobili di servizio completamente in acciaio inox AISI 304				
POLAR 2 AL + PPF		1 ripiano nella pratica alzata, portaposate a 6 scomparti e 2 porte.				
		Dotati di maniglia di spinta	CHF 2'914.00	RA	Rastrelliera in acciaio inox	CHF 248.00
Peso: 81 kg		4 Ruote ø125mm di cui 2 con freno				
Pag. 104 catalogo 2018						
		Moderni mobili di servizio completamente in acciaio inox AISI 304.				
POLAR 2 AP		2 ripiani e 2 cassetti. Dotati di maniglia di spinta.				
			CHF 3'386.75	RA	Rastrelliera in acciaio inox	CHF 248.00
Peso: 104 kg		4 Ruote ø125mm di cui 2 con freno				
Pag. 102 catalogo 2018						
		Moderni mobili di servizio completamente in acciaio inox AISI 304.				
POLAR 2 AP + PPF		2 ripiani e portaposate a 6 scomparti. Dotati di maniglia di spinta.				
			CHF 3'332.50	RA	Rastrelliera in acciaio inox	CHF 248.00
Peso: 101 kg		4 Ruote ø125mm di cui 2 con freno				
Pag. 102 catalogo 2018						
		Moderni mobili di servizio completamente in acciaio inox AISI 304.				
POLAR 2 CH		2 antine e 2 cassetti. Dotati di maniglia di spinta.				
			CHF 3'658.00	RA	Rastrelliera in acciaio inox	CHF 248.00
Peso: 112 kg		4 Ruote ø125mm di cui 2 con freno				
Pag. 103 catalogo 2018						
		Moderni mobili di servizio completamente in acciaio inox AISI 304.				
POLAR 2 CH + PPF		2 antine e portaposate a 6 scomparti. Dotati di maniglia di spinta.				
			CHF 3'580.50	RA	Rastrelliera in acciaio inox	CHF 248.00
Peso: 111 kg		4 Ruote ø125mm di cui 2 con freno				
Pag. 103 catalogo 2018						
		Moderni mobili di servizio completamente in acciaio inox AISI 304.				
POLAR 2 B		2 cassetti e 2 porte. Dotati di maniglia di spinta.				
			CHF 2'464.50	S/Q-ALK 2	Spondina di contenimento	CHF 142.60
Peso: 88 kg		4 Ruote ø125mm di cui 2 con freno				
Pag. 104 catalogo 2018						
		Moderni mobili di servizio completamente in acciaio inox AISI 304.				
POLAR 2 B + PPF		Portaposate a 6 scomparti e 2 porte. Dotati di maniglia di spinta.				
			CHF 2'402.50	S/Q-ALK 2	Spondina di contenimento	CHF 142.60
Peso: 86 kg		4 Ruote ø125mm di cui 2 con freno				
Pag. 104 catalogo 2018						

PERSEO - *Evergreen Style*

		Mobili di servizio in legno laminato per la sala ristorante.			B/R	Base rinforzata + maniglia	CHF 372.00
PERSEO A/1		Dotati di 2 cassetti e 1 sportello.			PP/F	Portaposate aperto	-
		Disponibili in 16 colori.	CHF 1'054.00	PER/CO	Copertura mobili	CHF 372.00	
Peso: 90 kg		4 ruote ø75mm			K	Chiusura porta/cassetto (x1)	CHF 108.50
Pag. 108 catalogo 2018					P	Ripiano extra	CHF 38.75
		Mobili di servizio in legno laminato per la sala ristorante.			B/R	Base rinforzata + maniglia	CHF 372.00
PERSEO A/2		Dotati di 2 cassetti e 2 sportelli.			PP/F	Portaposate aperto	-
		Disponibili in 16 colori.	CHF 1'131.50	PER/CO	Copertura mobili	CHF 372.00	
Peso: 94 kg		4 ruote ø75mm			K	Chiusura porta/cassetto (x1)	CHF 108.50
Pag. 108 catalogo 2018					P	Ripiano extra	CHF 38.75
		Mobili di servizio in legno laminato per la sala ristorante.			B/R	Base rinforzata + maniglia	CHF 372.00
PERSEO A/T		Dotati di 2 cassetti, 1 porta e 1 tramoggia.			PP/F	Portaposate aperto	-
		Disponibili in 16 colori.	CHF 1'410.50	PER/CO	Copertura mobili	CHF 372.00	
Peso: 96 kg		4 ruote ø75mm			K	Chiusura porta/cassetto (x1)	CHF 108.50
Pag. 110 catalogo 2018					P	Ripiano extra	CHF 38.75
		Mobili di servizio in legno laminato per la sala ristorante.					
PERSEO A/TA		Dotati di 2 cassetti, 1 porta e 1 tramoggia alta.			B/R	Base rinforzata + maniglia	CHF 372.00
		Disponibili in 16 colori.	CHF 1'379.50	PER/CO	Copertura mobili	CHF 372.00	
Peso: 96 kg		4 ruote ø75mm			K	Chiusura porta/cassetto (x1)	CHF 108.50
Pag. 110 catalogo 2018					P	Ripiano extra	CHF 38.75
		Mobili di servizio in legno laminato per la sala ristorante.			B/R	Base rinforzata + maniglia	CHF 372.00
PERSEO H/1		Dotati di 2 cassetti, 1 sportello e uno spazio portamenù.			PP/F	Portaposate aperto	-
		Disponibili in 16 colori.	CHF 1'116.00	PER/CO	Copertura mobili	CHF 372.00	
Peso: 82 kg		4 ruote ø75mm			K	Chiusura porta/cassetto (x1)	CHF 108.50
Pag. 111 catalogo 2018					P	Ripiano extra	CHF 38.75
		Mobili di servizio in legno laminato per la sala ristorante.			B/R	Base rinforzata + maniglia	CHF 372.00
PERSEO H/2		Dotati di 2 cassetti, 2 sportelli e uno spazio portamenù.			PP/F	Portaposate aperto	-
		Disponibili in 16 colori.	CHF 1'162.50	PER/CO	Copertura mobili	CHF 372.00	
Peso: 85 kg		4 ruote ø75mm			K	Chiusura porta/cassetto (x1)	CHF 108.50
Pag. 111 catalogo 2018					P	Ripiano extra	CHF 38.75
		Mobili di servizio in legno laminato per la sala ristorante.					
PERSEO 1		Dotati di 1 cassetto e 1 sportello.			K	Chiusura porta/cassetto (x1)	CHF 108.50
		Disponibili in 16 colori.	CHF 821.50	PP/F	Portaposate aperto	-	
Peso: 54 kg		4 ruote ø75mm			P	Ripiano extra	CHF 38.75
Non presente sul catalogo 2018							

PRODOTTI			OPTIONAL			
		Mobili di servizio in legno laminato per la sala ristorante.				
PERSEO G		Dotati di 1 cassetto e spazio aperto con ripiano intermedio.			K	Chiusura porta/cassetto (x1) CHF 108.50
		Disponibili in 16 colori.	CHF 744.00	PP/F		Portaposate aperto -
Peso: 51 kg		4 ruote ø75mm			P	Ripiano extra CHF 38.75
Pag. 112 catalogo 2018						
		Mobili di servizio in legno laminato per la sala ristorante.				
PERSEO BS/1		Dotati di 1 cassetto e 1 sportello			K	Chiusura porta/cassetto (x1) CHF 108.50
		Disponibili in 16 colori.	CHF 798.25	PP/F		Portaposate aperto -
Peso: 41 kg		4 ruote ø75mm			P	Ripiano extra CHF 38.75
Non presente sul catalogo 2018						
		Mobili di servizio in legno laminato per la sala ristorante.				
PERSEO 75		Dotati di 1 cassetto, 3 compartimenti verticali e 1 sportello.			K	Chiusura porta/cassetto (x1) CHF 108.50
		Disponibili in 16 colori.	CHF 999.75	PP/F		Portaposate aperto -
Peso: 80 kg		4 ruote ø75mm			P	Ripiano extra CHF 38.75
Pag. 112 catalogo 2018						
		Mobili di servizio in legno laminato per la sala ristorante.				
PERSEO B/1		Dotati di 2 cassette, spazio aperto con ripiano intermedio e 1 sportello.			B/R	Base rinforzata + maniglia CHF 372.00
		Disponibili in 16 colori.	CHF 1'007.50	PP/F		Copertura mobili -
Peso: 71 kg		4 ruote ø75mm			K	Chiusura porta/cassetto (x1) CHF 108.50
Non presente sul catalogo 2018					P	Ripiano extra CHF 38.75
		Mobili di servizio in legno laminato per la sala ristorante.				
PERSEO B/2		Dotati di 2 cassette e 2 sportelli.			B/R	Base rinforzata + maniglia CHF 372.00
		Disponibili in 16 colori.	CHF 1'038.50	PP/F		Copertura mobili -
Peso: 74 kg		4 ruote ø75mm			K	Chiusura porta/cassetto (x1) CHF 108.50
Pag. 113 catalogo 2018					P	Ripiano extra CHF 38.75
		Mobili di servizio in legno laminato per la sala ristorante.				
PERSEO B/TA		Dotati di 2 cassette e 1 tramoggia alta estraibile con sacco di cotone.			B/R	Base rinforzata + maniglia CHF 372.00
		Disponibili in 16 colori.	CHF 1'255.50	K		Chiusura porta/cassetto (x1) CHF 108.50
Peso: 76 kg		4 ruote ø75mm			P	Ripiano extra CHF 38.75
Pag. 113 catalogo 2018						

MEDUSA - *Design classico*

MEDUSA 2/2 Peso: 105 kg Pag. 114 catalogo 2018		Mobili di servizio in legno laminato per la sala ristorante.		TR	Tramoggia	CHF 350.30
		Dotati di 2 cassetti e 2 sportelli.		B/R	Base rinforzata + maniglia	CHF 372.00
		Disponibili in 16 colori.	CHF 1'147.00	PP/F	Copertura mobili	-
		4 ruote ø75mm		K	Chiusura porta/cassetto (x1)	CHF 108.50
				P	Ripiano extra	CHF 38.75
MEDUSA 2/AL Peso: 145 kg Pag. 114 catalogo 2018		Mobili di servizio in legno laminato per la sala ristorante.		TR	Tramoggia	CHF 350.30
		Alzata con 2 sportelli in vetro sabbato. Dotati di 2 cassetti e 2 sportelli inferiori.		B/R	Base rinforzata + maniglia	CHF 372.00
		Disponibili in 16 colori.	CHF 2'092.50	PP/F	Copertura mobili	-
		4 ruote ø75mm		K	Chiusura porta/cassetto (x1)	CHF 108.50
				P	Ripiano extra	CHF 38.75
MEDUSA 3/2 Peso: 146 kg Pag. 115 catalogo 2018		Mobili di servizio in legno laminato per la sala ristorante.		TR	Tramoggia	CHF 350.30
		Dotati di 3 cassetti, spazio aperto con ripiano intermedio e 2 sportelli.		B/R	Base rinforzata + maniglia	CHF 372.00
		Disponibili in 16 colori.	CHF 1'472.50	PP/F	Copertura mobili	-
		4 ruote ø75mm		K	Chiusura porta/cassetto (x1)	CHF 108.50
				P	Ripiano extra	CHF 38.75
MEDUSA 3/AL Peso: 194 kg Pag. 115 catalogo 2018		Mobili di servizio in legno laminato per la sala ristorante.		TR	Tramoggia	CHF 350.30
		Alzata con 3 sportelli in vetro sabbato. Dotati di 3 cassetti e 2 sportelli inferiori.		B/R	Base rinforzata + maniglia	CHF 372.00
		Disponibili in 16 colori.	CHF 2'666.00	PP/F	Copertura mobili	-
		4 ruote ø75mm		K	Chiusura porta/cassetto (x1)	CHF 108.50
				P	Ripiano extra	CHF 38.75